



TUBULAR SOLENOIDS

| Push type

Transmotec sell a broad range of high quality solenoids in standard and customized configurations. Transmotec is the ideal supplier source especially to instrument and apparatus builders. We keep a high number of motors in stock for immediate delivery.

Customizations include:

- ✓ Customized harness
- ✓ Winding configuration
- ✓ Plunger configuration
- ✓ And more...

TABLE OF CONTENTS

Model	Diameter	Length	Page
T1130S	Ø11mm	30.5mm	1
T1325S	Ø12.7mm	26.2mm	2
T1632S	Ø16mm	32mm	3
T1939S	Ø20.2mm	39.3mm	4
T2551S	Ø25.4mm	50.8mm	5
T3257S	Ø31.8mm	57.5mm	6
T3864S	Ø38.1mm	64mm	7

T1130S (push type)

DRAWING (mm)

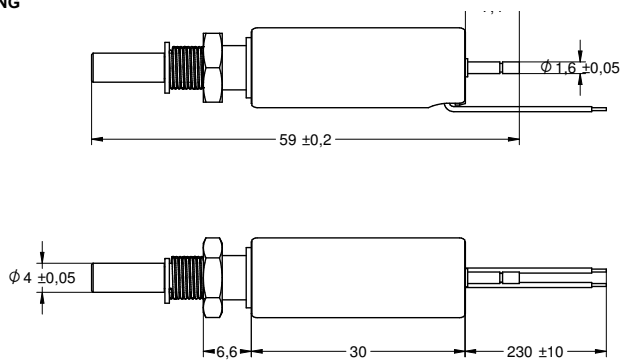

PHOTO



MODEL NO. DESIGNATION

T1130S - VOLTAGE
Example: T1130S-06V

SOLENOID DATA

Duty cycle / ED (%) ▶	Continuous (100%)	Intermittent (50%)	Intermittent (25%)	Intermittent (10%)
Watts @ 20°C ▶	4	8	16	40
Maximum time in energized state (in seconds) ▶	∞	50	5	2
Part ▼	Resistance (20°C) ± 10% (Ω) ▼	DC Volts (V) ▼		
T1130S-06V	9	6	8.5	12
T1130S-12V	36	12	17	24
T1130S-24V	144	24	34	48

SOLENOID FEATURES AND STANDARD DATA

	STANDARD	CUSTOMIZATION OPTIONS
Type	Push type DC solenoid	Push type DC solenoid
Cable	Flying wire 230mm	Length, type and connector
Voltage	6 to 24 VDC @ 100% ED	Other voltages upon request
Life time	At least 500.000 single strokes	
Plunger material	Carbon steel 12L14	
Protection class	IP50	
Insulation grade	B	
Operating temperature	-5°C ... +40°C	
Manufacturing quality standards	ISO9001:2008, ISO/TS 16949:2002	
RoHS compliance	Yes	
CE approval	No	
UL approval	No	

ADDITIONAL DATA

Return spring	Yes
Weight	17g

SPRING DATA

Loading force @ 5mm compression	58 ± 10% g
---------------------------------	------------

PLUNGER PROFILE

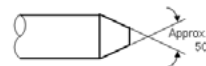

DIAGRAM

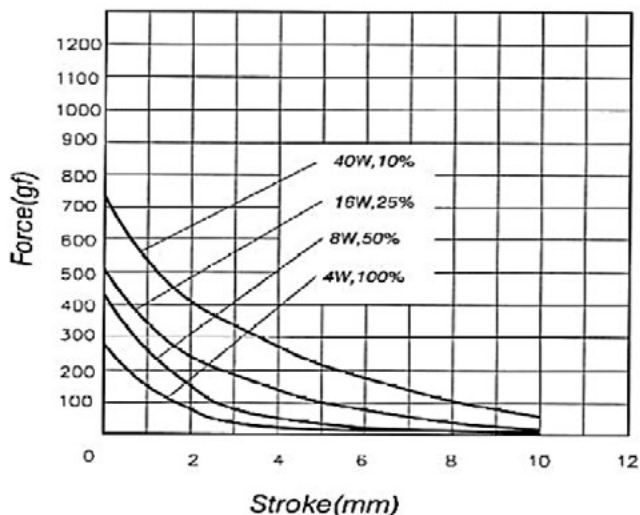

T1325S (push type)

DRAWING (mm)

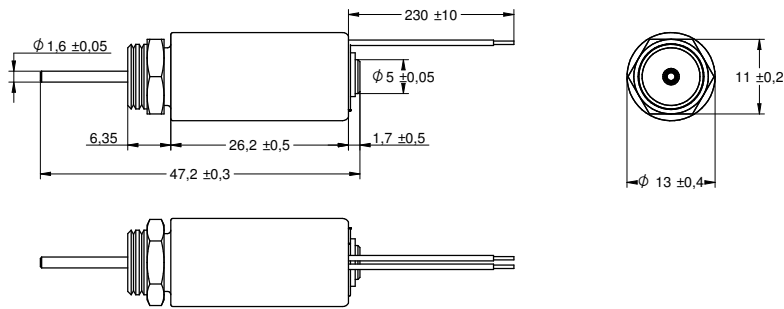

PHOTO



MODEL NO. DESIGNATION

T1325S - VOLTAGE
Example: T1325S-06V

SOLENOID DATA

Duty cycle / ED (%) ▶	Continuous (100%)	Intermittent (50%)	Intermittent (25%)	Intermittent (10%)
Watts @ 20°C ▶	4	8	16	40
Maximum time in energized state (in seconds) ▶	∞	50	5	2

Part ▼	Resistance (20°C) $\pm 10\%$ (Ω) ▼	DC Volts (V) ▼			
T1325S-06V	9	6	8.5	12	19
T1325S-12V	36	12	17	24	38
T1325S-24V	144	24	34	48	76

SOLENOID FEATURES AND STANDARD DATA

	STANDARD	CUSTOMIZATION OPTIONS
Type	Push type DC solenoid	Push type DC solenoid
Cable	Flying wire 230mm	Length, type and connector
Voltage	6 to 24 VDC @ 100% ED	Other voltages upon request
Life time	At least 500.000 single strokes	
Plunger material	Carbon steel 12L14	
Protection class	IP50	
Insulation grade	B	
Operating temperature	-5°C ... +40°C	
Manufacturing quality standards	ISO9001:2008, ISO/TS 16949:2002	
RoHS compliance	Yes	
CE approval	No	
UL approval	No	

ADDITIONAL DATA

Return spring	Yes
Weight	23g

SPRING DATA

Loading force @ 4mm compression	18-22g
---------------------------------	--------

PLUNGER PROFILE

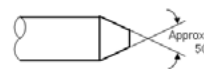

DIAGRAM

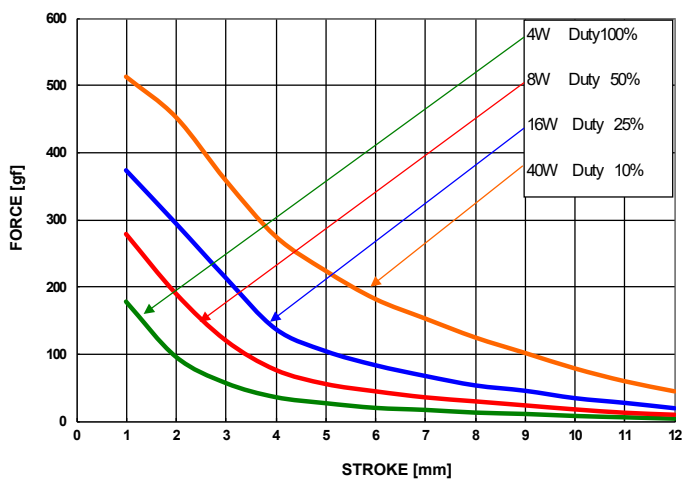

T1632S (push type)

DRAWING (mm)

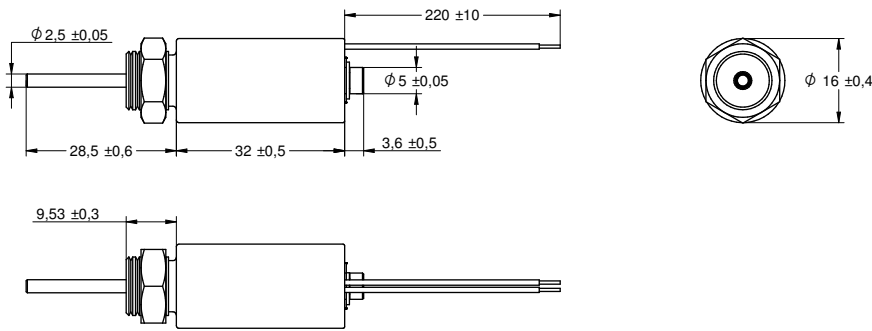

PHOTO



MODEL NO. DESIGNATION

T1632S - VOLTAGE
Example: T1632S-12V

SOLENOID DATA

Duty cycle / ED (%) ▶	Continuous (100%)	Intermittent (50%)	Intermittent (25%)	Intermittent (10%)	
Watts @ 20°C ▶	5.5	11	22	55	
Maximum time in energized state (in seconds) ▶	∞	230	25	6	
Part ▼	Resistance (20°C) ± 10% (Ω) ▼	DC Volts (V) ▼			
T1632S-06V	6.5	6	8.5	12	19
T1632S-12V	26.2	12	17	24	38
T1632S-24V	104.7	24	34	48	76

SOLENOID FEATURES AND STANDARD DATA

	STANDARD	CUSTOMIZATION OPTIONS
Type	Push type DC solenoid	Push type DC solenoid
Cable	Flying wire 230mm	Length, type and connector
Voltage	6 to 24 VDC @ 100% ED	Other voltages upon request
Life time	At least 500.000 single strokes	
Plunger material	Carbon steel 12L14	
Protection class	IP50	
Insulation grade	B	
Operating temperature	-5°C ... +40°C	
Manufacturing quality standards	ISO9001:2008, ISO/TS 16949:2002	
RoHS compliance	Yes	
CE approval	No	

ADDITIONAL DATA

Return spring	Yes
Weight	47g

SPRING DATA

Loading force @ 2mm compression	70 ± 10g
---------------------------------	----------

PLUNGER PROFILE

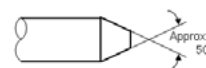

DIAGRAM

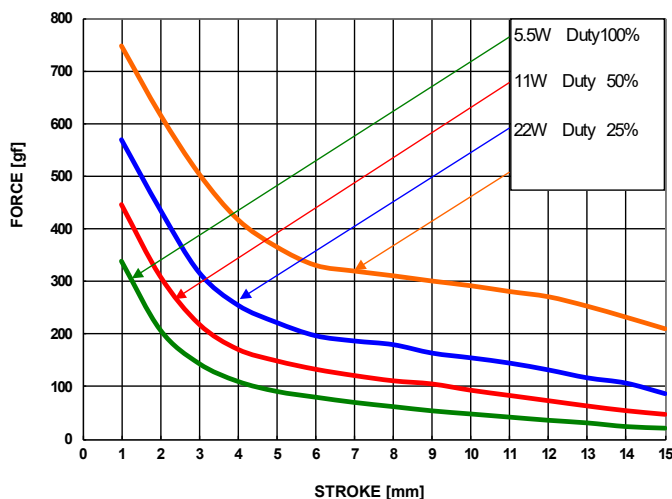

T1939S (push type)

DRAWING (mm)

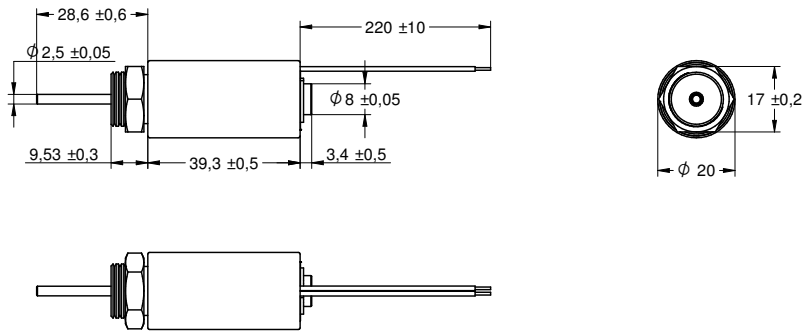

PHOTO



MODEL NO. DESIGNATION

T1939S - VOLTAGE

Example: T1939S -12V

SOLENOID DATA

Duty cycle / ED (%) ▶	Continuous (100%)	Intermittent (50%)	Intermittent (25%)	Intermittent (10%)	
Watts @ 20°C ▶	7	14	28	70	
Maximum time in energized state (in seconds) ▶	∞	230	25	6	
Part ▼	Resistance (20°C) ± 10% (Ω) ▼	DC Volts (V) ▼			
T1939S-06V	5.14	6	8.5	12	19
T1939S-12V	20.6	12	17	24	38
T1939S-24V	82.3	24	34	48	76

SOLENOID FEATURES AND STANDARD DATA

	STANDARD	CUSTOMIZATION OPTIONS
Type	Push type DC solenoid	Push type DC solenoid
Cable	Flying wire 230mm	Length, type and connector
Voltage	6 to 24 VDC @ 100% ED	Other voltages upon request
Life time	At least 500.000 single strokes	
Plunger material	Carbon steel 12L14	
Protection class	IP50	
Insulation grade	B	
Operating temperature	-5°C ... +40°C	
Manufacturing quality standards	ISO9001:2008, ISO/TS 16949:2002	
RoHS compliance	Yes	
CE approval	No	
UL approval	No	

ADDITIONAL DATA

Return spring	Yes
Weight	82g

SPRING DATA

Loading force @ 5mm compression	48 ± 5g
---------------------------------	---------

PLUNGER PROFILE

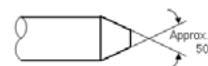

DIAGRAM

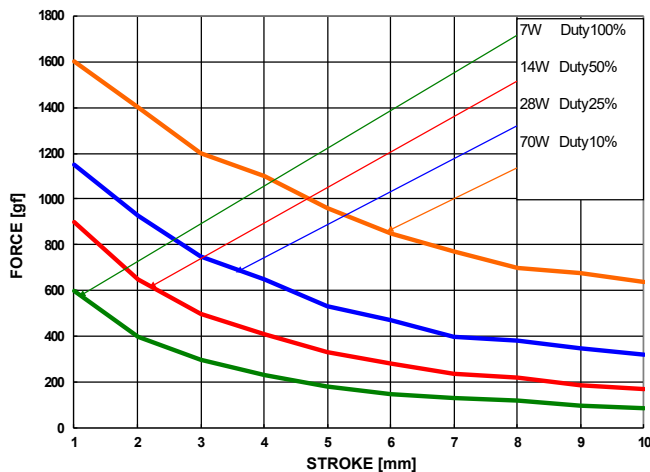

T2551S (push type)

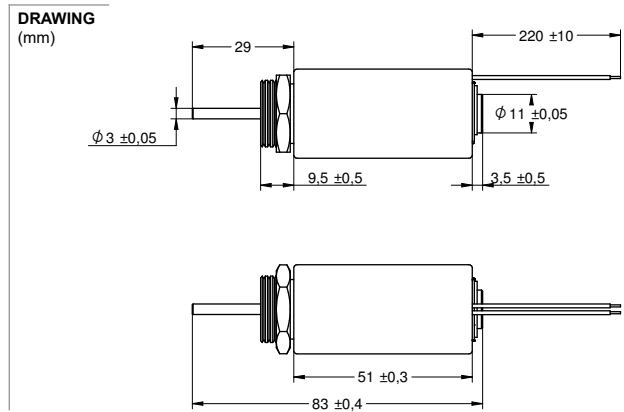

MODEL NO. DESIGNATION

T2551S - VOLTAGE

Example: T2551S-12V

SOLENOID DATA				
Duty cycle / ED (%) ▶	Continuous (100%)	Intermittent (50%)	Intermittent (25%)	Intermittent (10%)
Watts @ 20°C ▶	10	20	40	100
Maximum time in energized state (in seconds) ▶	∞	360	32	8
Part ▼	Resistance (20°C) ± 10% (Ω) ▼	DC Volts (V) ▼		
T2551S-06V	3.6	6	8.5	12
T2551S-12V	14.4	12	17	24
T2551S-24V	57.6	24	34	48

SOLENOID FEATURES AND STANDARD DATA		
	STANDARD	CUSTOMIZATION OPTIONS
Type	Push type DC solenoid	Push type DC solenoid
Cable	Flying wire 230mm	Length, type and connector
Voltage	6 to 24 VDC @ 100% ED	Other voltages upon request
Life time	At least 500.000 single strokes	
Plunger material	Carbon steel 12L14	
Protection class	IP50	
Insulation grade	B	
Operating temperature	-5°C ... +40°C	
Manufacturing quality standards	ISO9001:2008, ISO/TS 16949:2002	
RoHS compliance	Yes	
CE approval	No	
UL approval	No	

ADDITIONAL DATA	
Return spring	Yes
Weight	178g

SPRING DATA	
Loading force @ 2.7mm compression	210 ± 15g



DIAGRAM

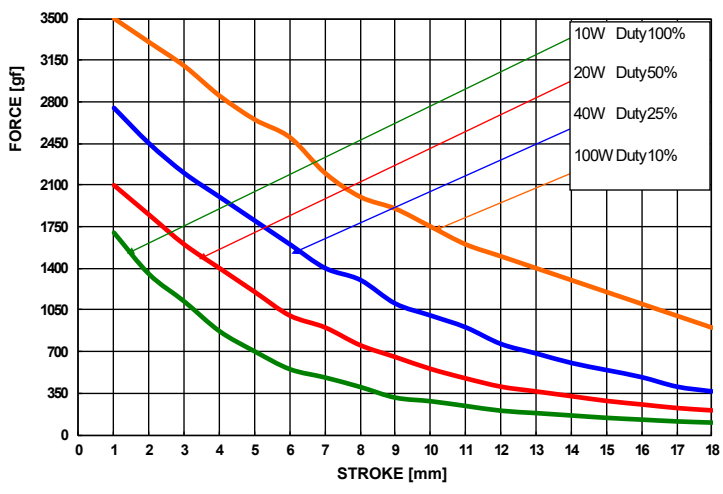

T3257S (push type)

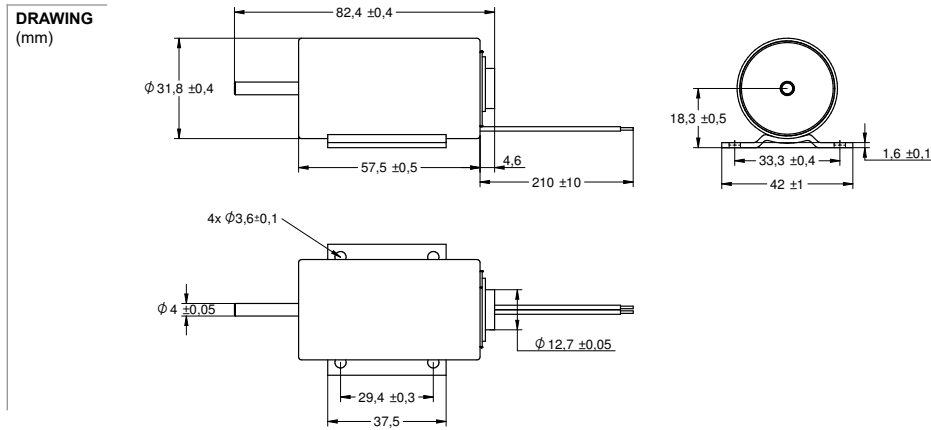

PHOTO



MODEL NO. DESIGNATION

T3257S - VOLTAGE
 Example: T3257S-12V

SOLENOID DATA				
Duty cycle / ED (%) ▶	Continuous (100%)	Intermittent (50%)	Intermittent (25%)	Intermittent (10%)
Watts @ 20°C ▶	12.96	25.92	51.84	129.6
Maximum time in energized state (in seconds) ▶	∞	390	60	18
Part ▼	Resistance (20°C) ± 10% (Ω) ▼	DC Volts (V) ▼		
T3257S-06V	2.77	6	8.5	12
T3257S-12V	11.07	12	17	24
T3257S-24V	44.3	24	34	48

SOLENOID FEATURES AND STANDARD DATA		
	STANDARD	CUSTOMIZATION OPTIONS
Type	Push type DC solenoid	Push type DC solenoid
Cable	Flying wire 230mm	Length, type and connector
Voltage	6 to 24 VDC @ 100% ED	Other voltages upon request
Life time	At least 500.000 single strokes	
Plunger material	Carbon steel 12L14	
Protection class	IP50	
Insulation grade	B	
Operating temperature	-5°C ... +40°C	
Manufacturing quality standards	ISO9001:2008, ISO/TS 16949:2002	
RoHS compliance	Yes	
CE approval	No	
UL approval	No	

ADDITIONAL DATA	
Return spring	Yes
Weight	295g

SPRING DATA	
Loading force @ 10mm compression	210 ± 10g



DIAGRAM

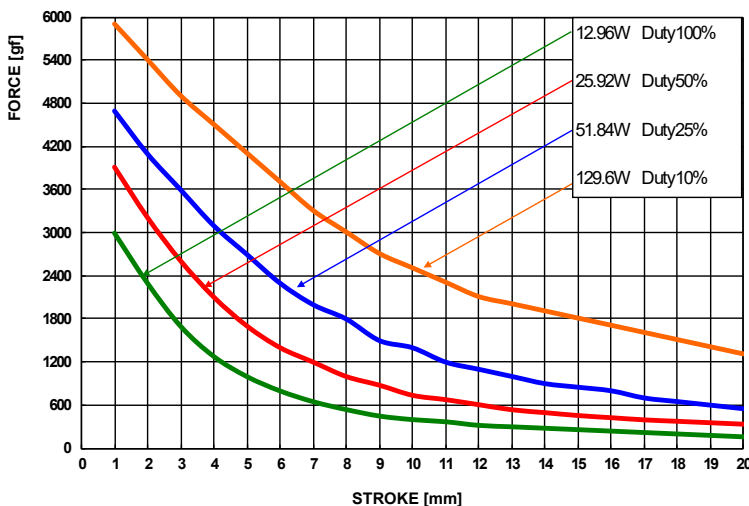

T3864S (push type)

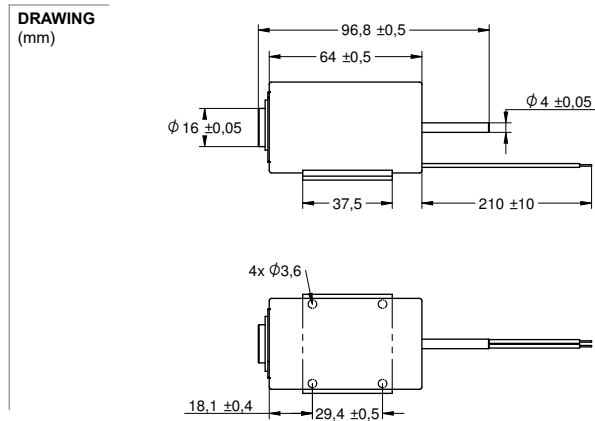

PHOTO



MODEL NO. DESIGNATION

T3864S - VOLTAGE
 Example: T3864S-12V

SOLENOID DATA				
Duty cycle / ED (%) ▶	Continuous (100%)	Intermittent (50%)	Intermittent (25%)	Intermittent (10%)
Watts @ 20°C ▶	16.8	33.6	67.2	168
Maximum time in energized state (in seconds) ▶	∞	420	100	25
Part ▼	Resistance (20°C) ± 10% (Ω) ▼	DC Volts (V) ▼		
T3864S-06V	2.1	6	8.5	12
T3864S-12V	8.5	12	17	24
T3864S-24V	34	24	34	48

SOLENOID FEATURES AND STANDARD DATA		
	STANDARD	CUSTOMIZATION OPTIONS
Type	Push type DC solenoid	Push type DC solenoid
Cable	Flying wire 230mm	Length, type and connector
Voltage	6 to 24 VDC @ 100% ED	Other voltages upon request
Life time	At least 500.000 single strokes	
Plunger material	Carbon steel 12L14	
Protection class	IP50	
Insulation grade	B	
Operating temperature	-5°C ... +40°C	
Manufacturing quality standards	ISO9001:2008, ISO/TS 16949:2002	
RoHS compliance	Yes	
CE approval	No	
UL approval	No	

ADDITIONAL DATA	
Return spring	No
Weight	497g

PLUNGER PROFILE

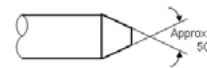

DIAGRAM

